

**SEMİKRON**  
innovation + service

欢迎金色俱乐部成员

# 大功率太阳能转换器 (250 - 750kW)

2008 十一月



# 太阳能工业需求/销售 1982 - 2007

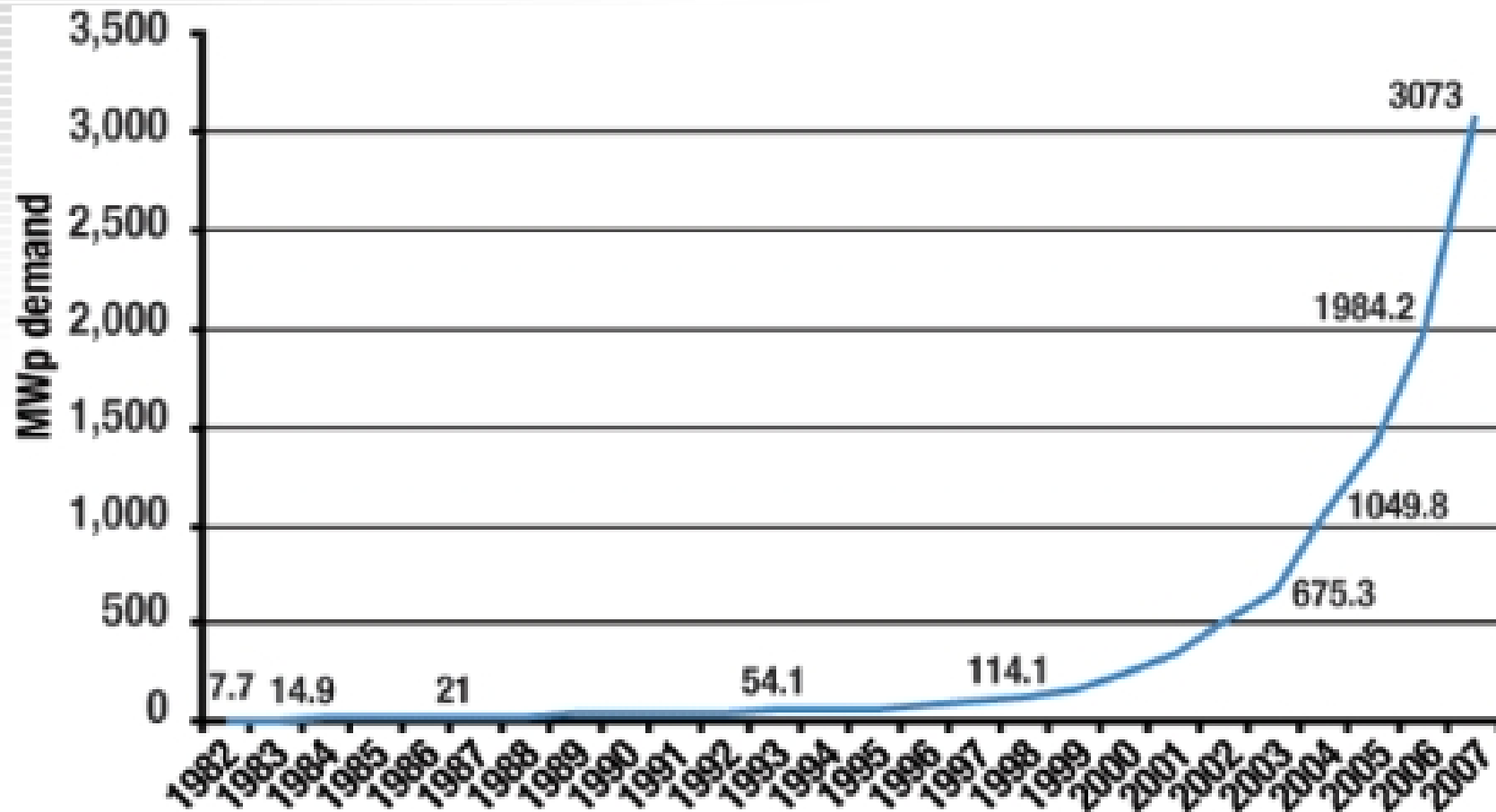

累计, 从1970年代起全球超过 10.3 GW 的光电产品被装配, 其中50%的产品是在近三年内被装配。

# 从硅晶到太阳能电池模块



硅

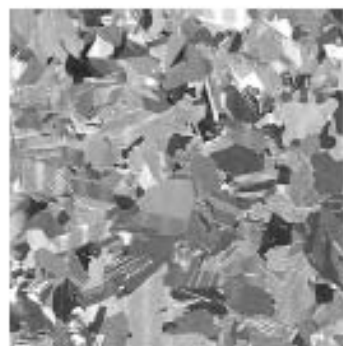

硅晶元

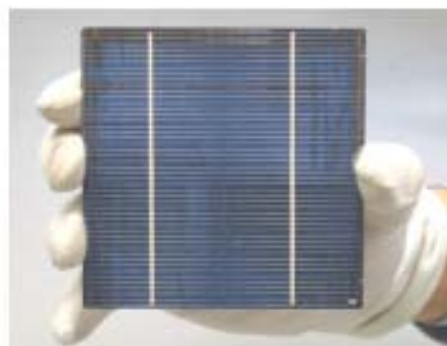

太阳能电池



太阳能电池模块

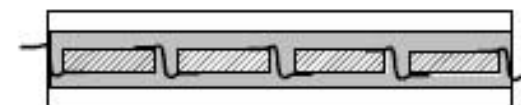

# 太阳能系统

太阳能模块

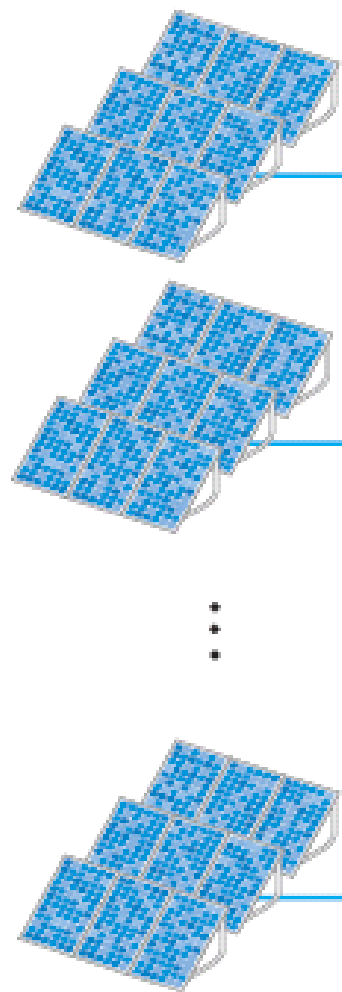

太阳能转换器

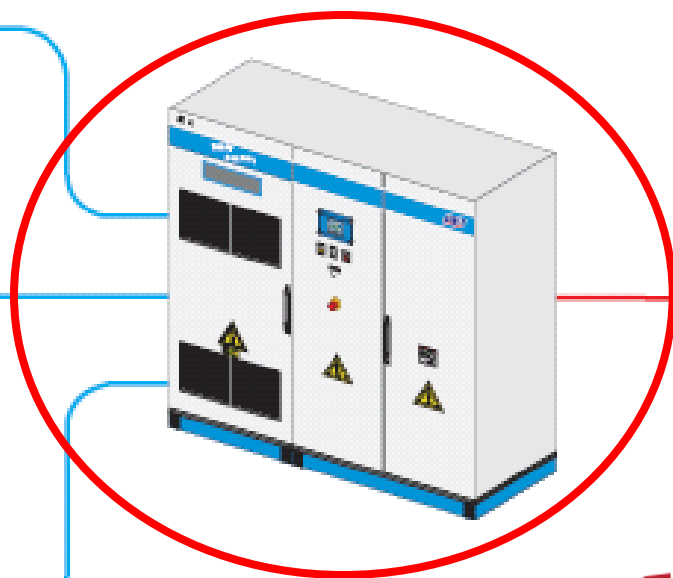

电网

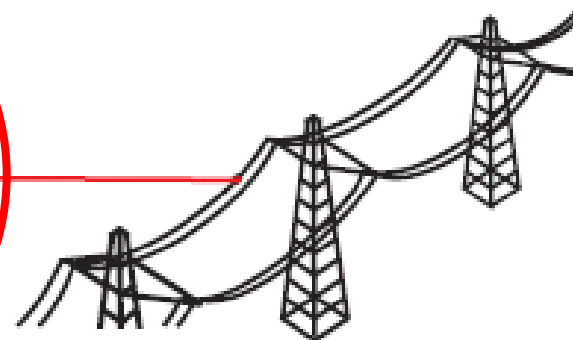

**SEMIKRON**  
innovation+service



# 太阳能转换器的功能

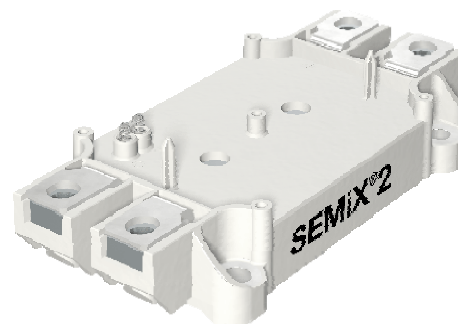
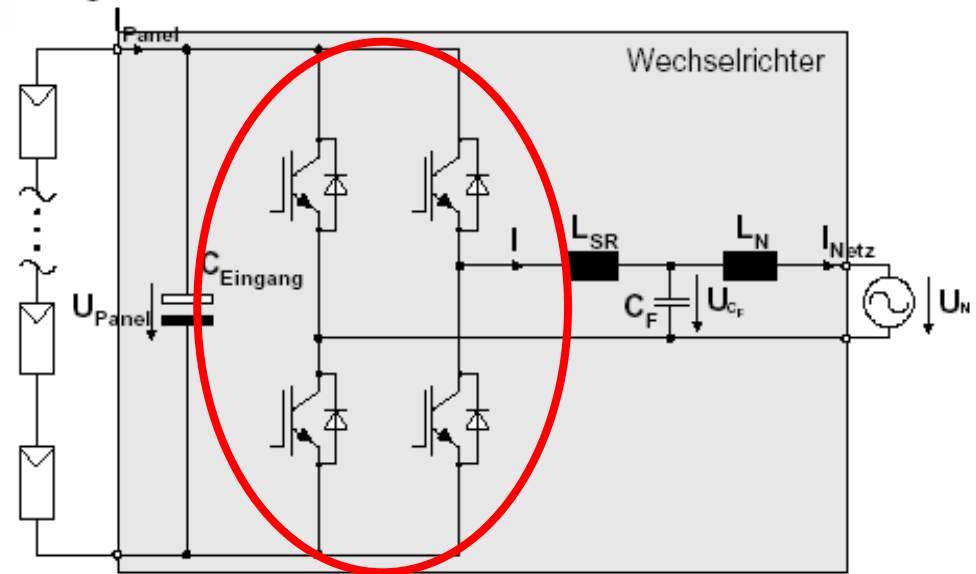
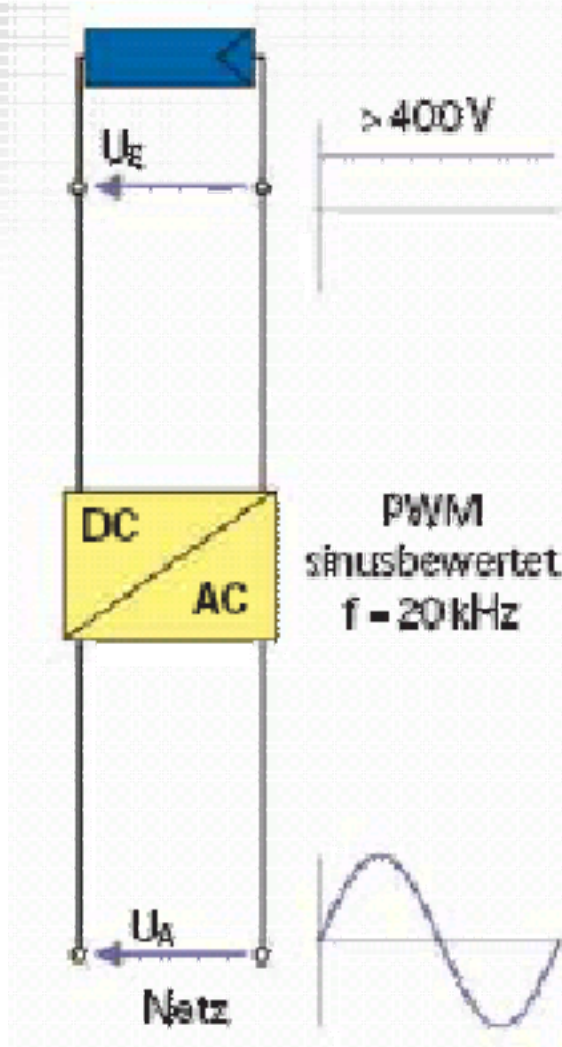

# 新的太阳能转换器概念

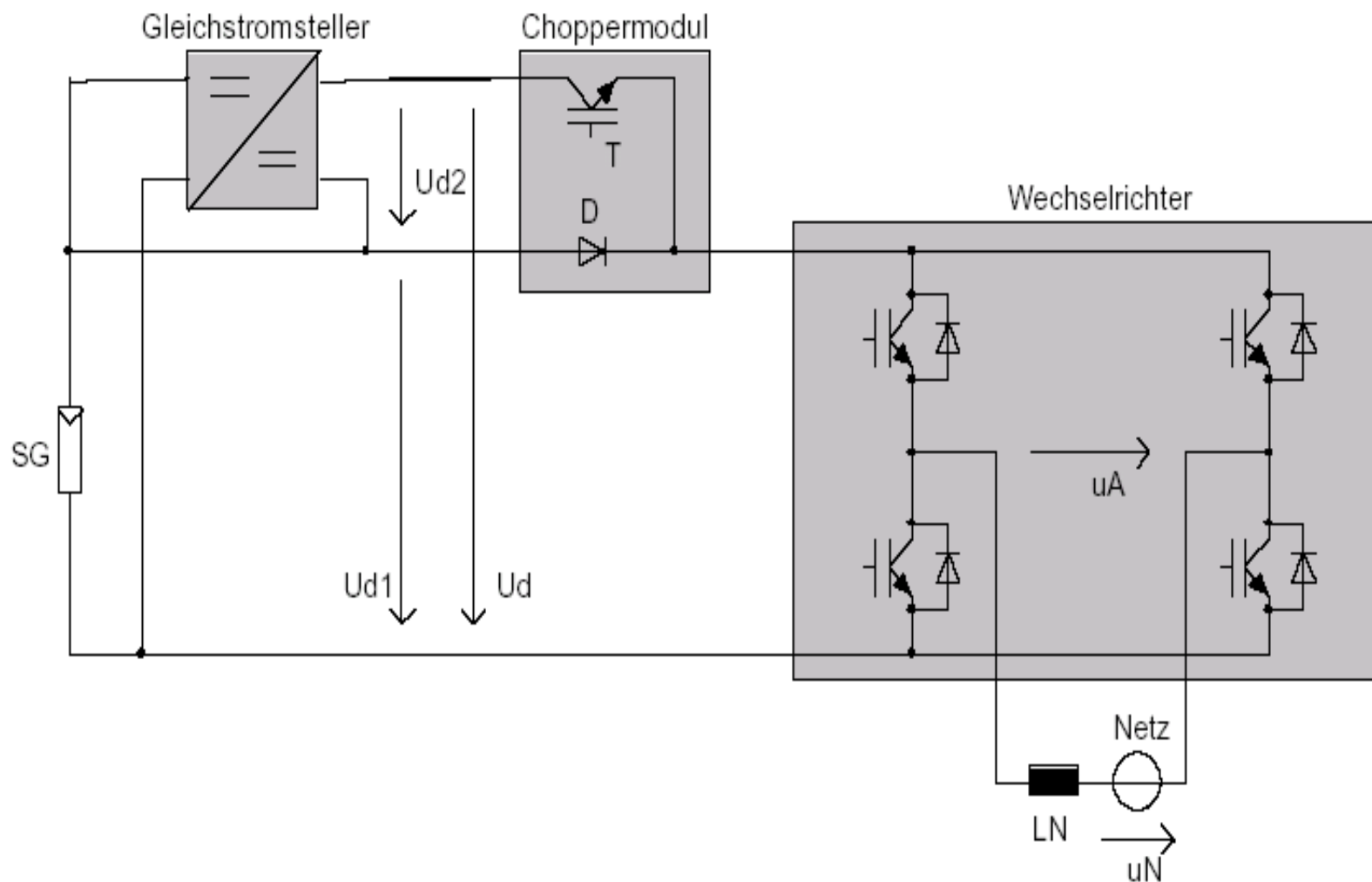

# 输出信号 (电压和电流)

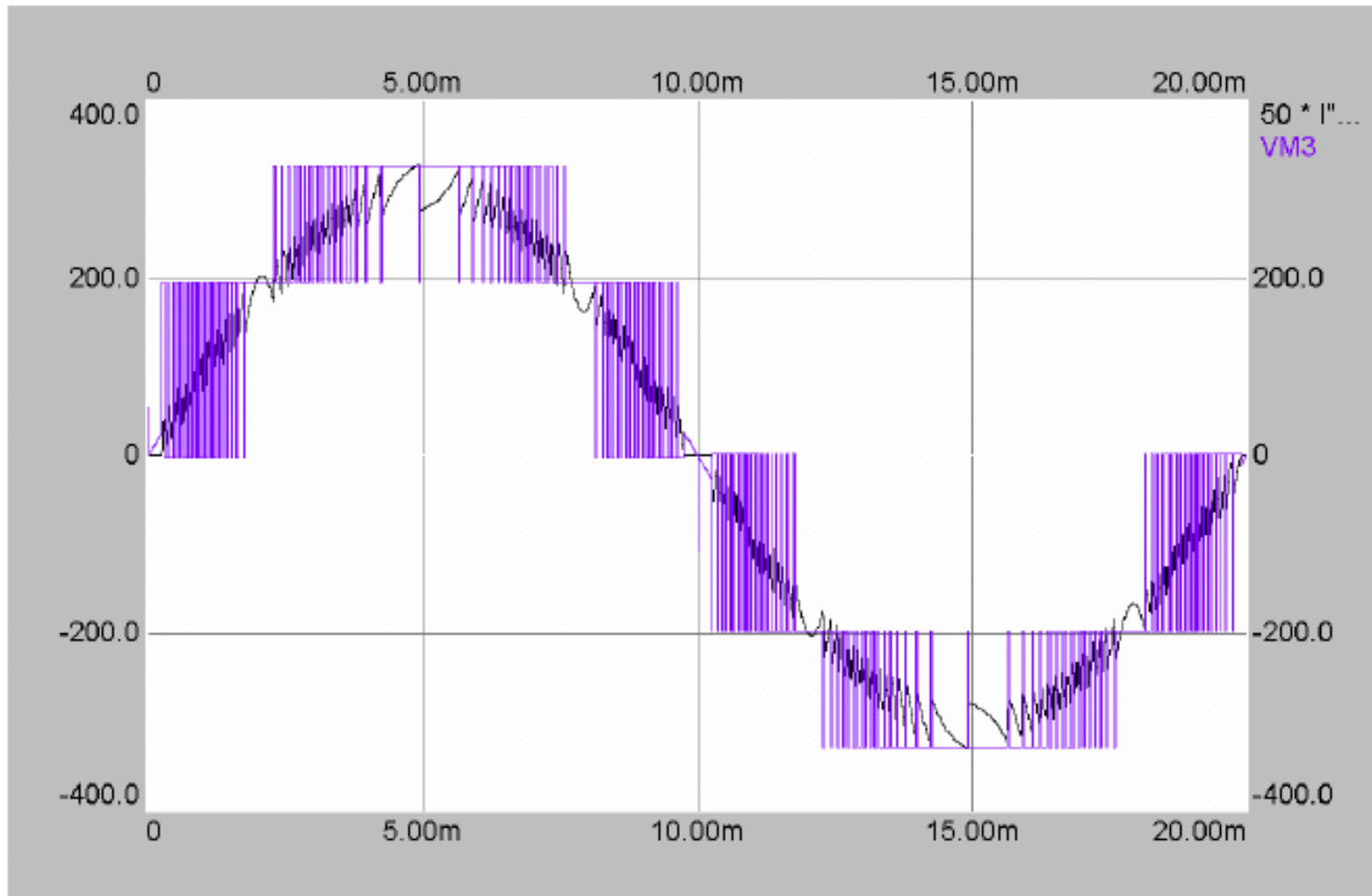

# 新太阳能转换器技术

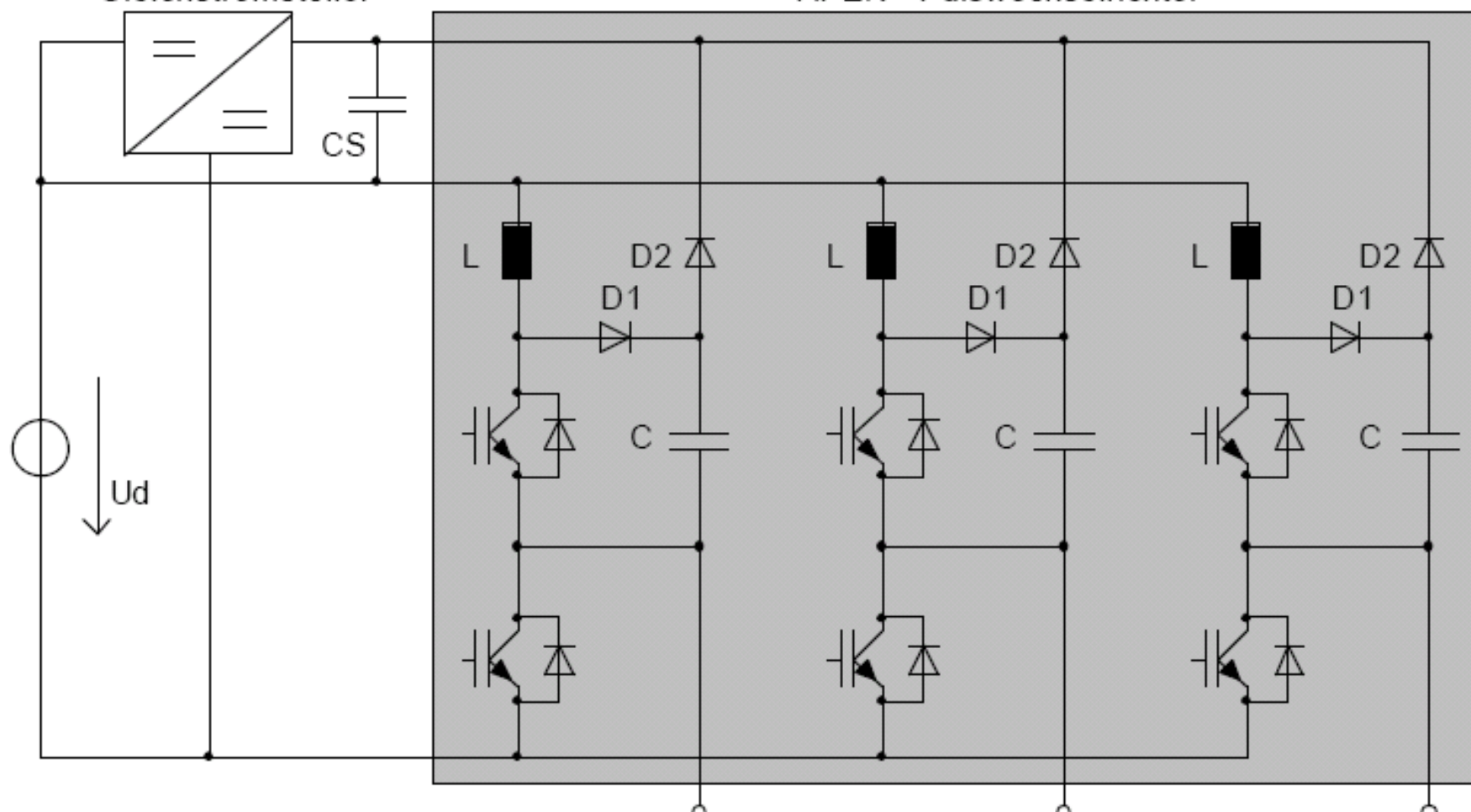

# 串联转换器

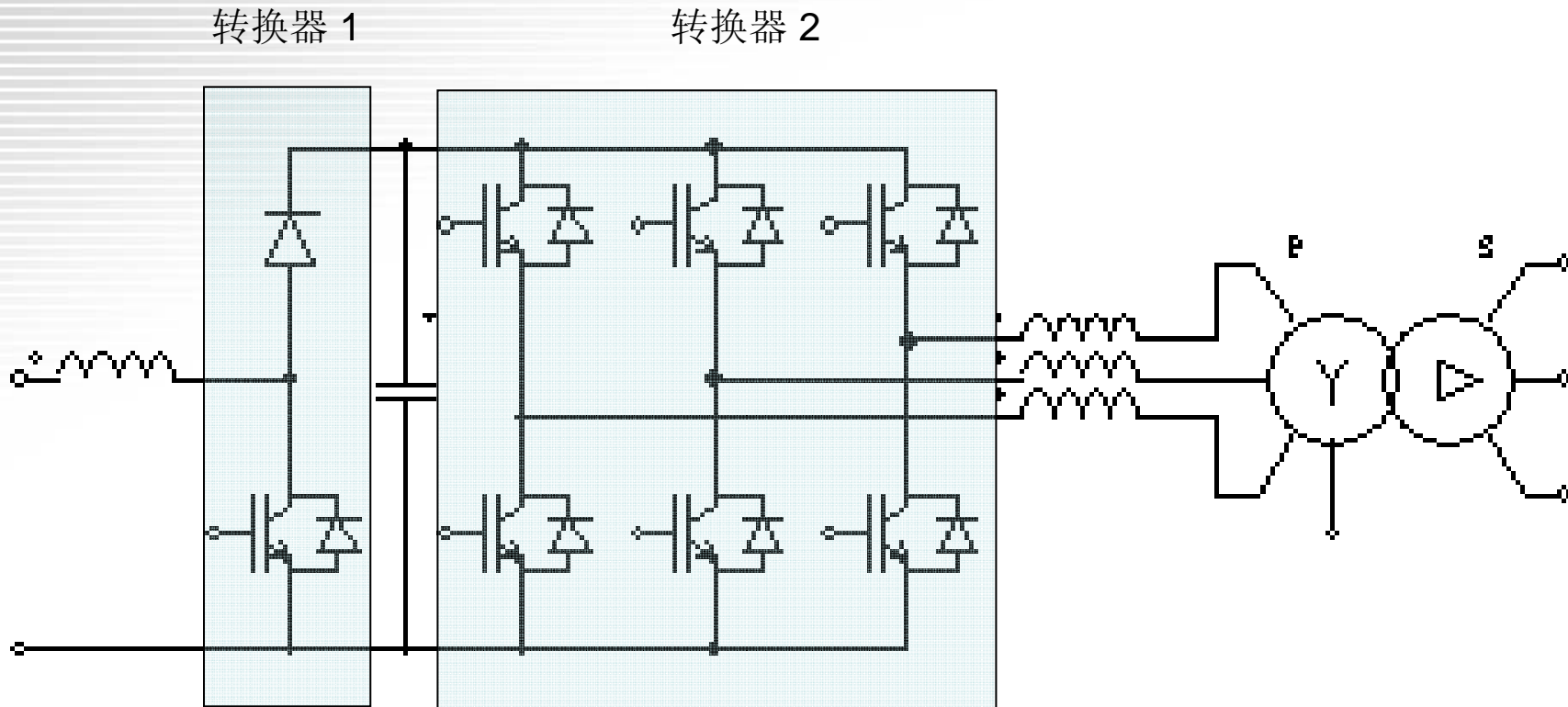

特性:

两个转换器串联, 升压斩波 + 逆变器  
为高电压和高电流而设计的标准箱

调节系数  $m=1$

标准电网侧转换器 (3 x 400V...690V)

# 三级转换器

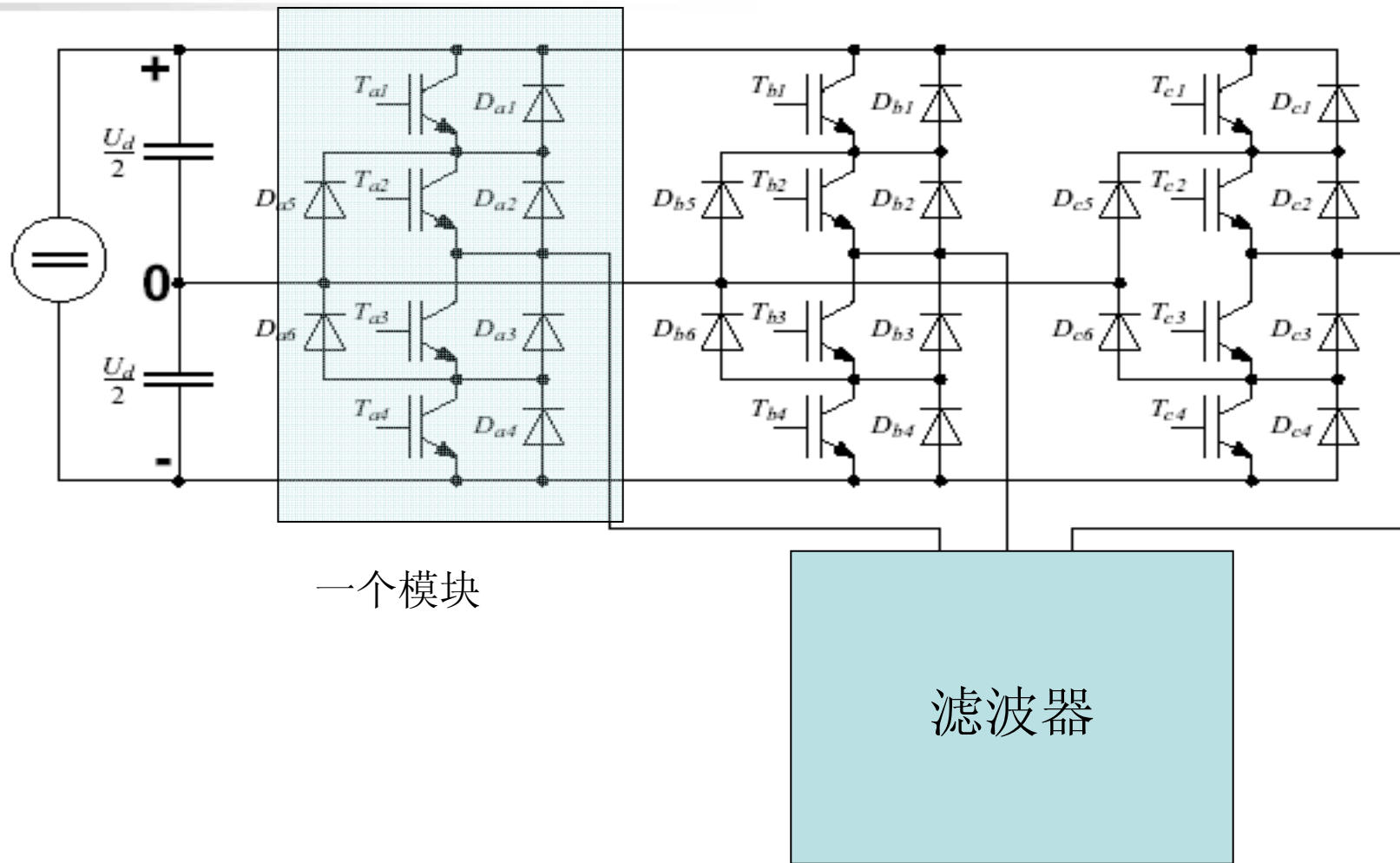

# 多极逆变器拓扑结构

## ➤ 单项多极逆变器模块

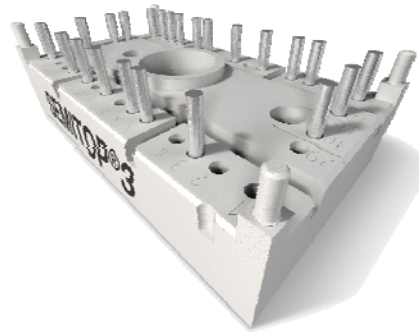
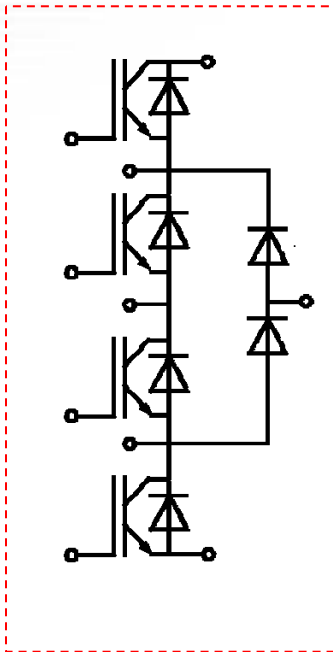

### SEMITOP 3

SK 25 MLI 065

SK 50 MLI 065



### SEMITOP 4

SK 75 MLI 065

SK 100 MLI 065

...达到 100A!

# 3级 SEMITOP 适用范围

10

30

80

[kVA]

SEMISTOP 3

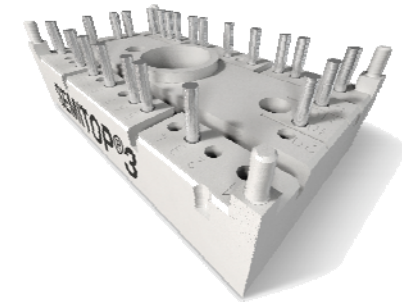

SEMISTOP 4

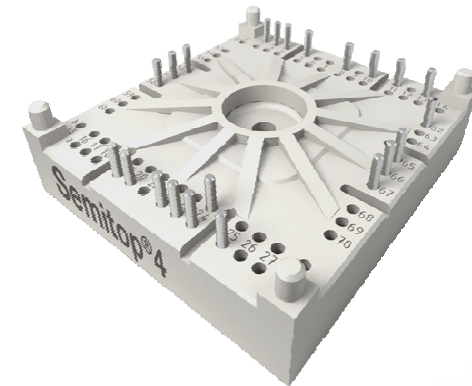

工作环境

- ▶  $\text{Cos } \phi = 1$
- ▶  $m = 1$
- ▶  $T_s = 70^\circ\text{C}$
- ▶  $F_{sw} = 20\text{kHz}$

# SEMITOP3 图示识别 → 10 - 30KVA

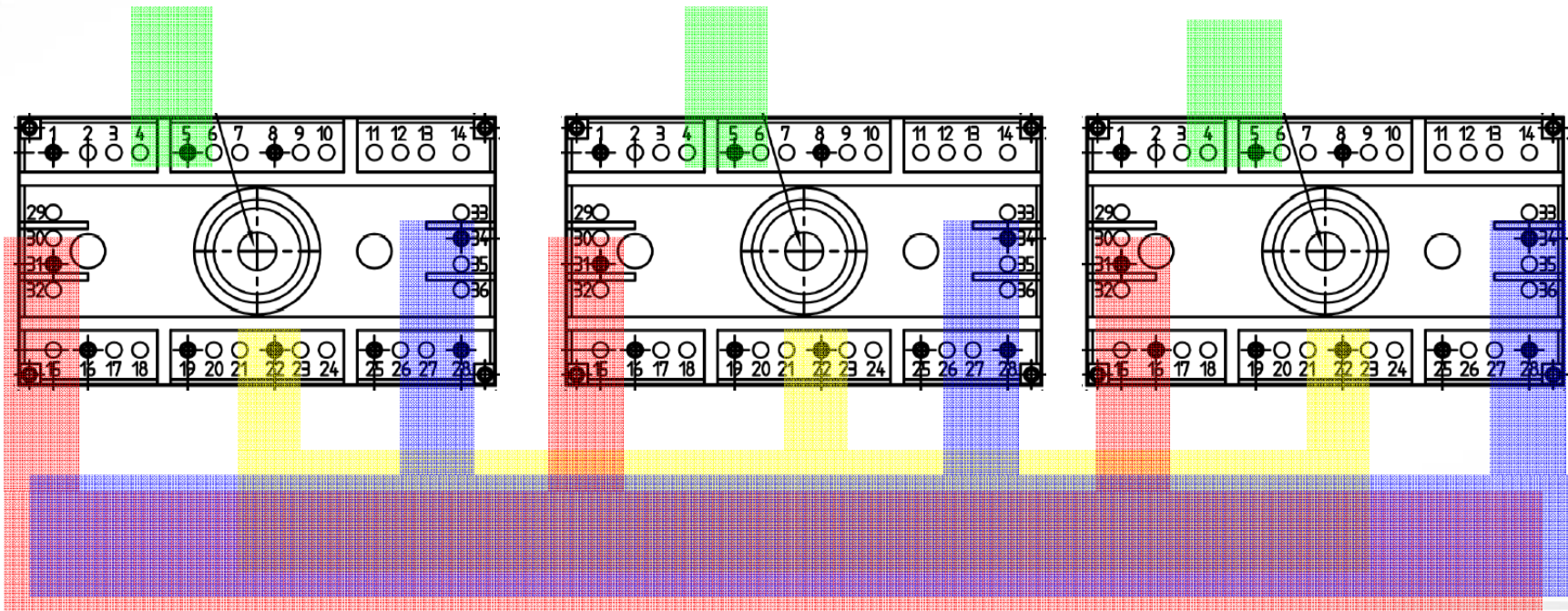
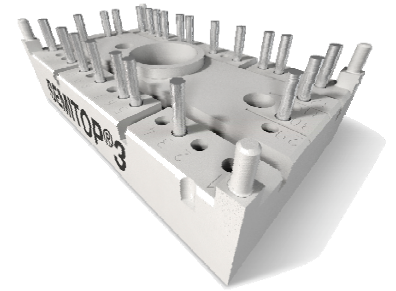

# SEMITOP4 图示识别 → 40 - 80KVA

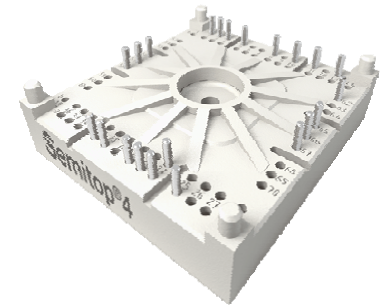

- 正极
- 负极
- 中性极
- 相位输出

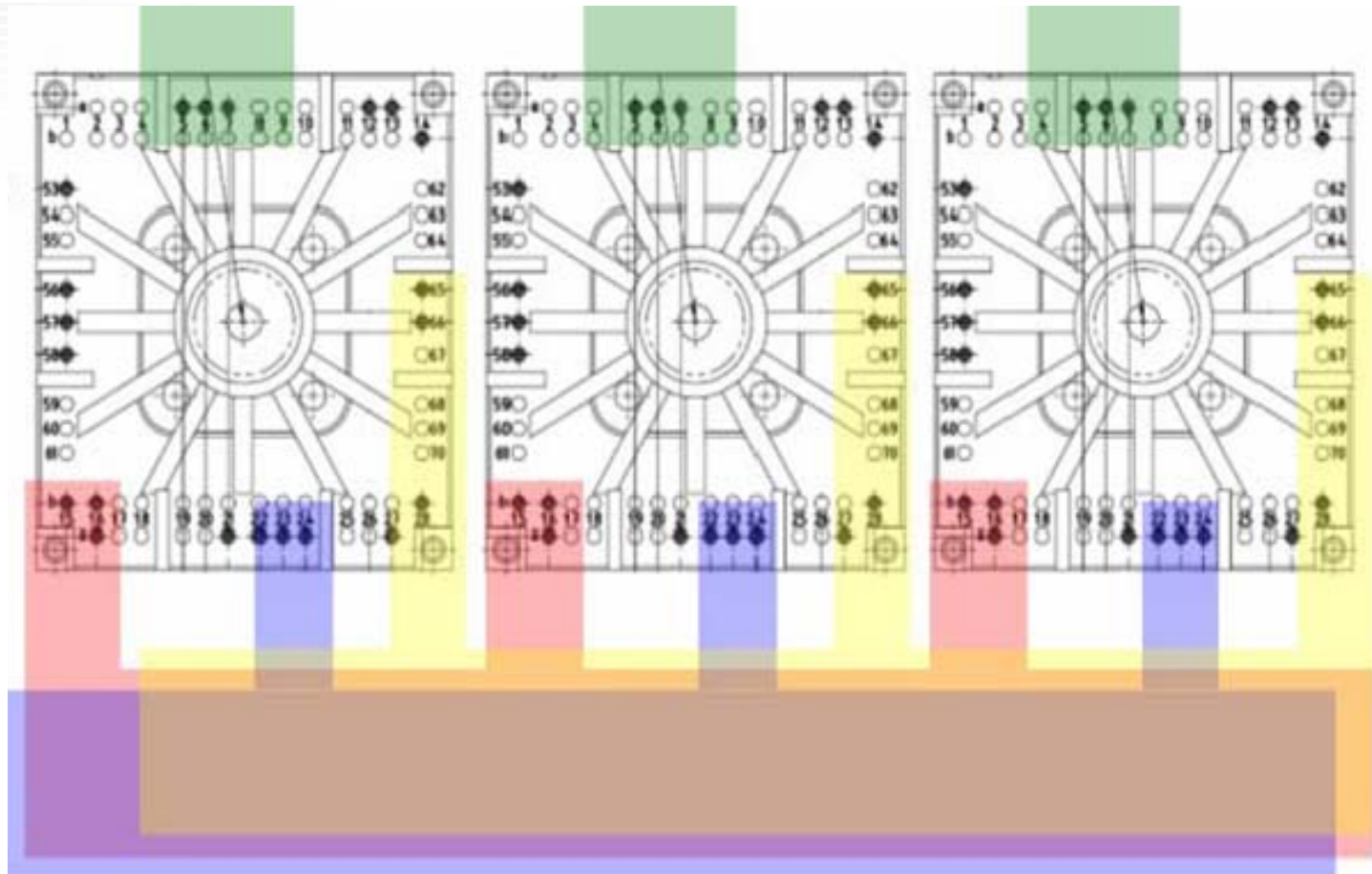

- 切换频率可到 2 – 4 kHz (>250 kHz)
- 太阳能电池和转换器之间的升压部件可以增加运行范围。
- 太阳能电池和转换器之间的升压器可以在不同脉冲模式下运行
- 凭借更高的 DC 总线电压使效能增加
- 无基板的IGBT可以增加寿命和减少芯片温度。(更好的热膨胀系数和更好的热阻)

# 无基板的IGBT – SKiP 技术

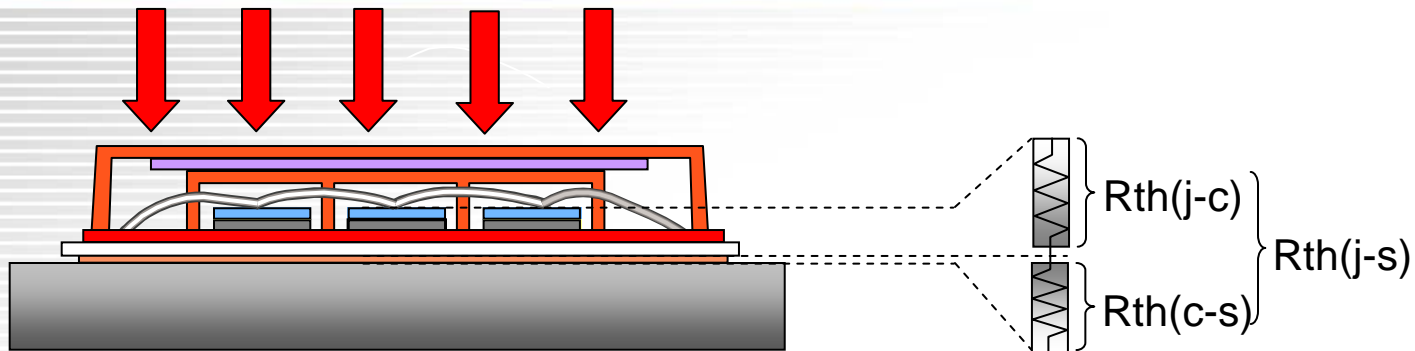

SKiP 压接技术

**30% 更好 Rth(j-s)**

类型		条件	典型值	最大值	总计I	单位
SEMİKRON 2403GB172-4DW	Rth(j-s)	Per IGBT		0,013	<b>0,013</b>	K/W
Competitor Module with base plate	Rth(j-c)	Per IGBT		0,008	<b>0,017</b>	K/W
	Rth(c-h)	Per IGBT	0,009			K/W

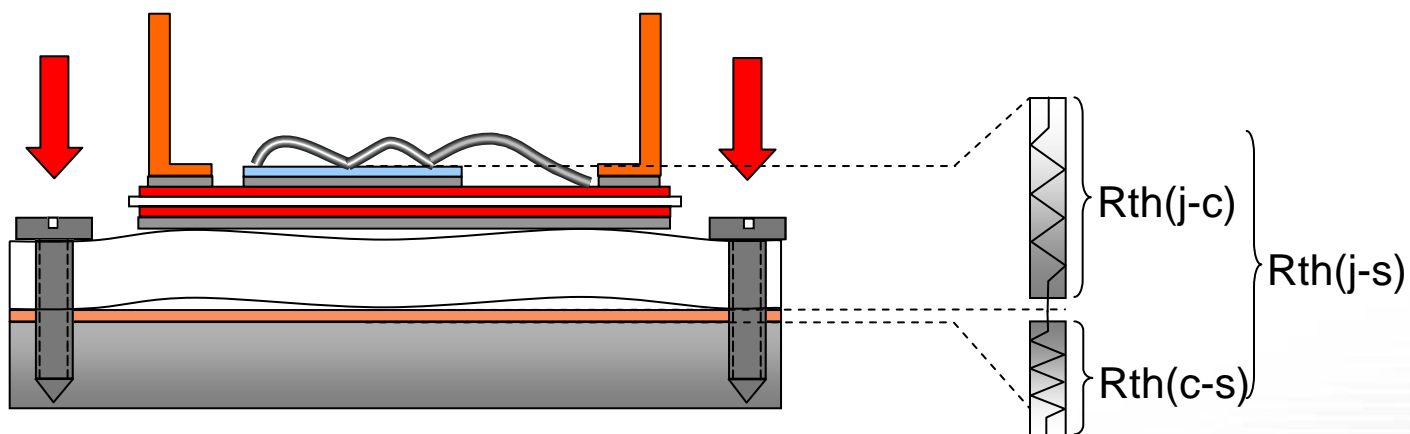

标准基板模块

# 适用各种功率的模块

**Semitop**

可达 20KVA

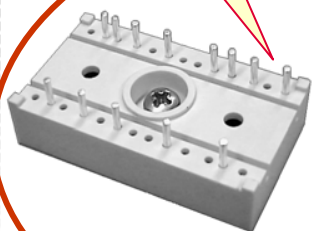

**MiniSKiiP**

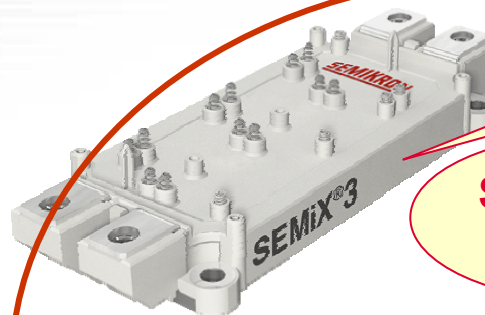

**SEMiX**

**SEMiX with SKYPER**

可达 100 KVA

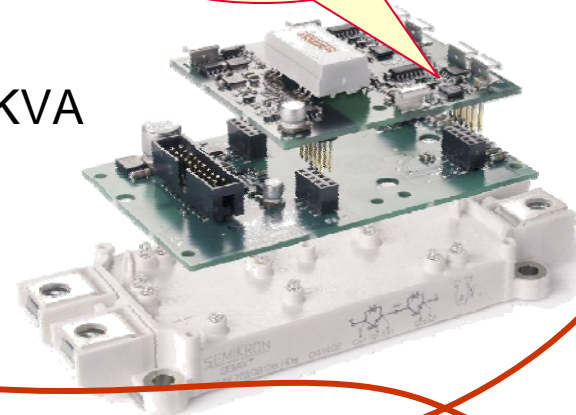

可达 750 KVA

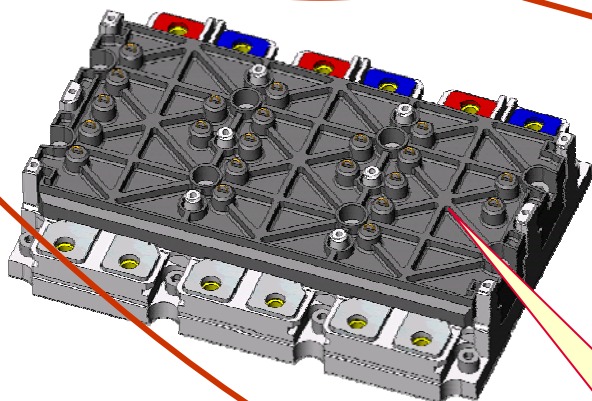

**SKiM63/93**

**SKiiP 3**

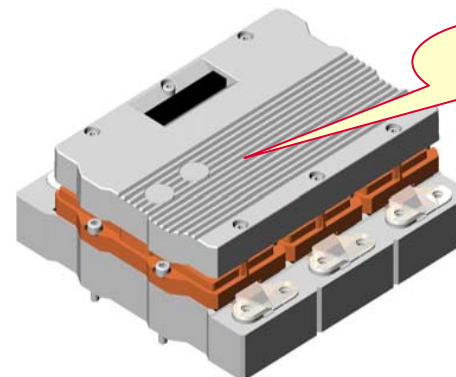

# 450KVA 空气冷却太阳能转换器

## 3相转换器

$F_s = 3 \text{ KHz}$

$V_{\text{line}} = 400\text{V}$

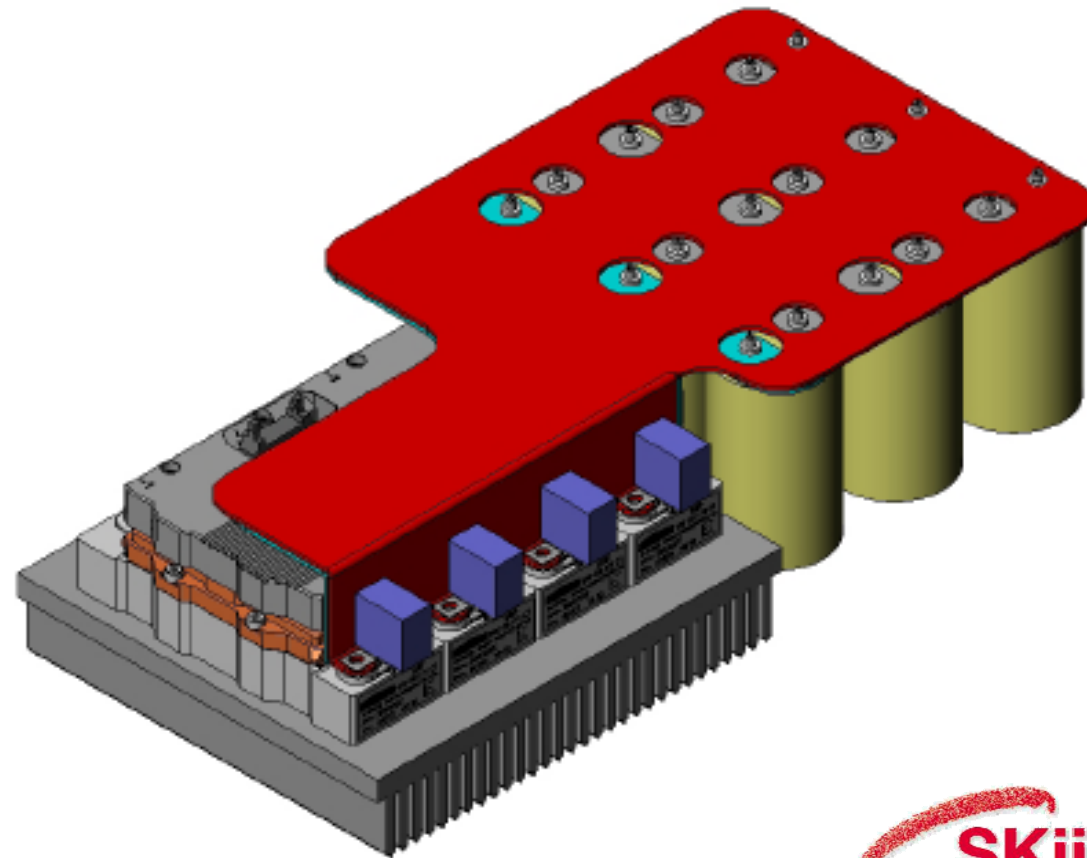

# 欧洲地区连接到电网上的太阳能转换器技术的趋势图

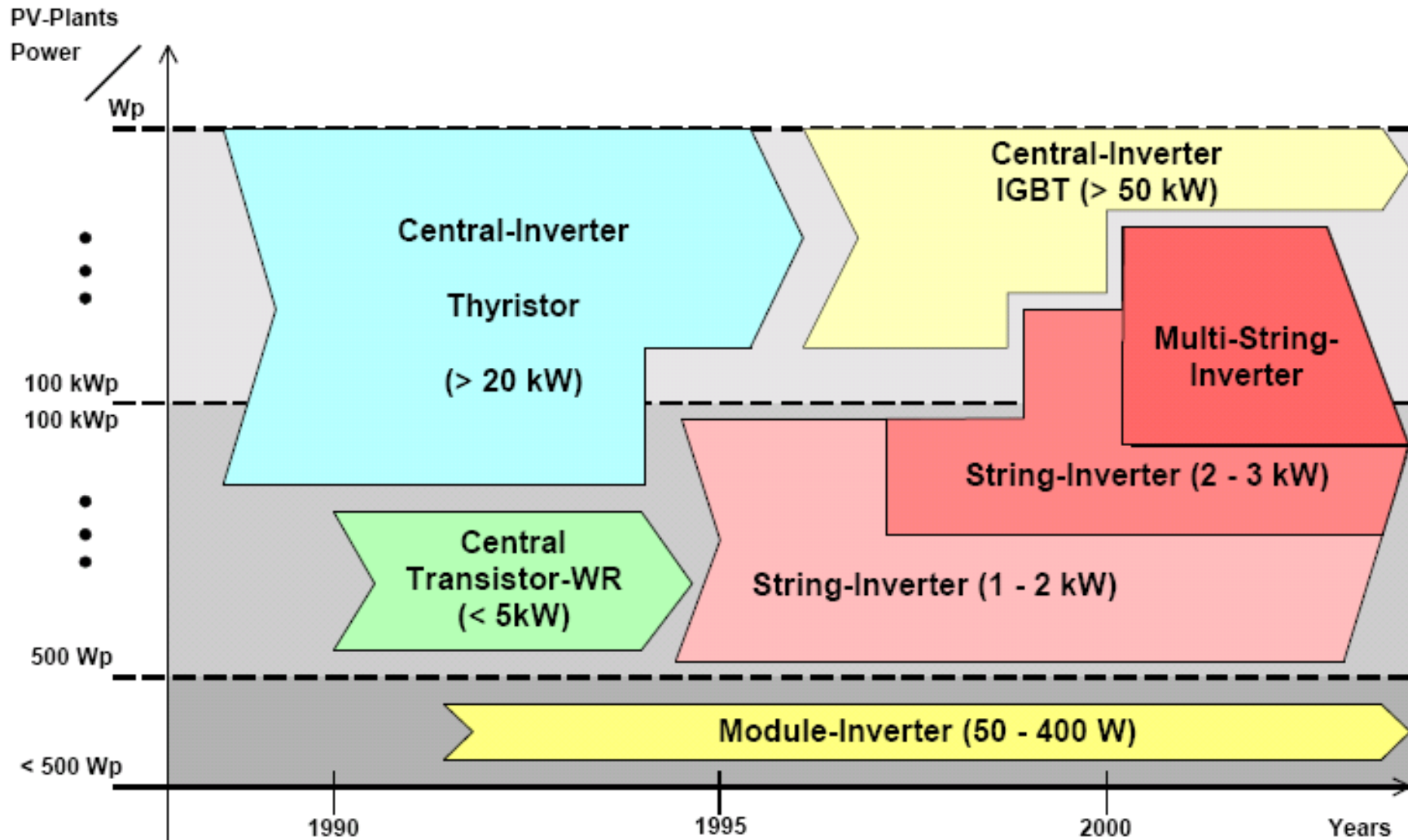

中国电能消耗 -----28200 GW-----风能 3.29 GW-----太阳能 0.01GW

风能和太阳能可以实现完全相同的电网效果

风能转换器 (电网侧) 可以转换为电能转换器

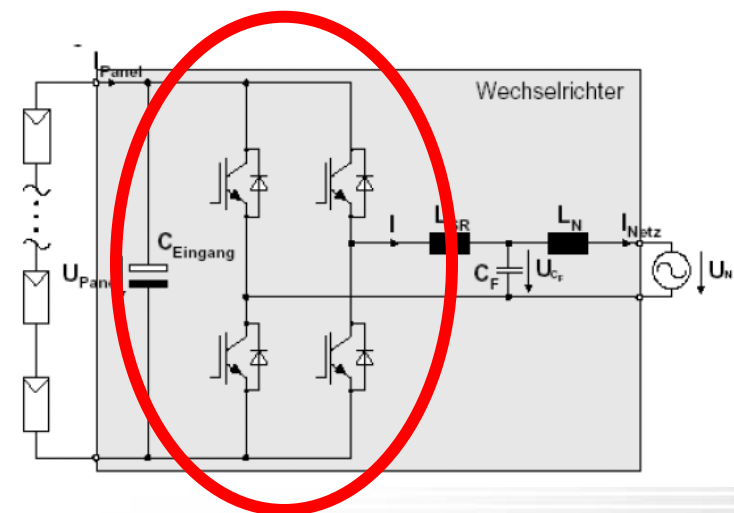
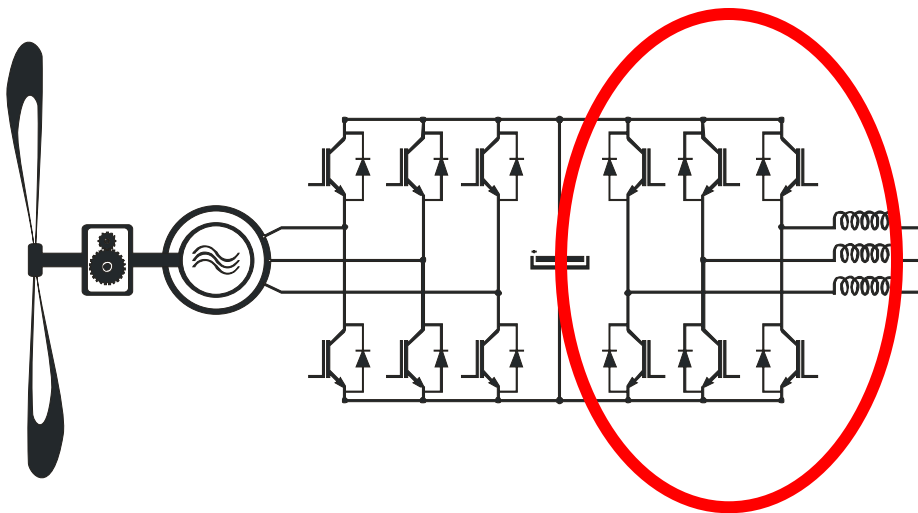

# 关注**2008年12月**

**2008年12月28日**发行

## 圆形器件装配说明书

- 结构
- 装配说明
- 功耗计算
- 圆形器件集成装置